

Basic settings disc coulters and skimming devices

Disc coulters

The disc coulters should produce a clean cut 20 mm outside the landside.

The disc coulters should never be set deeper in the ground than 1/3 of their diameter.

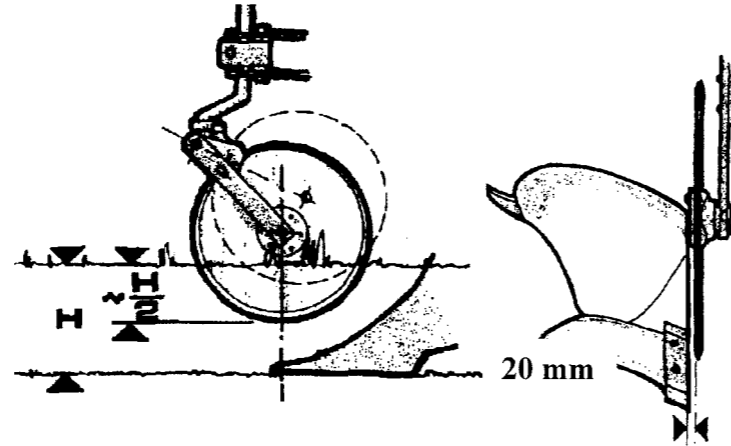

Basic setting of skimmers (20cm ploughing depth)

Horizontal measurement - H

Mesure between skimmer bracket and rear part of the beam

H = 300 mm when fin coulters are mounted.

H = 270 mm when disc coulters are mounted.

Depth adjustment - V

The distance is measured between the main frame and the the skimmer share point.

Under beam clearance 75cm V = 540 mm

Under beam clearance 80cm V = 620 mm

The skimmer share points should be set to cut approximately 10 mm outside the landsides.

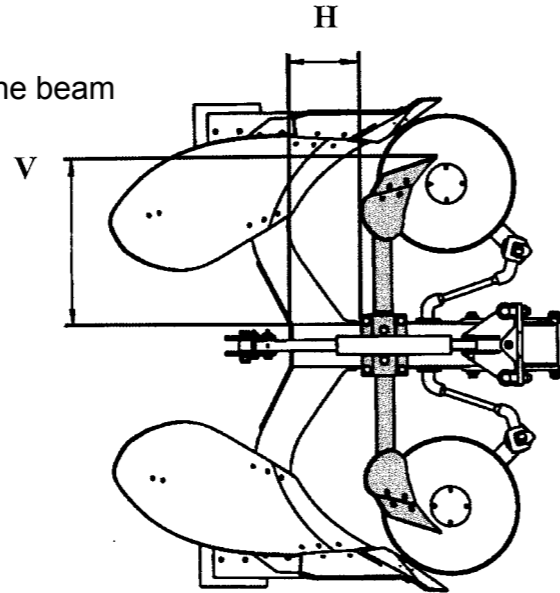

Cover boards

The front part of the cover boards should have contact with the mouldboard shin. The outer end has to be adjusted according to the ploughing depth.

Basic adjustment B. =430 mm

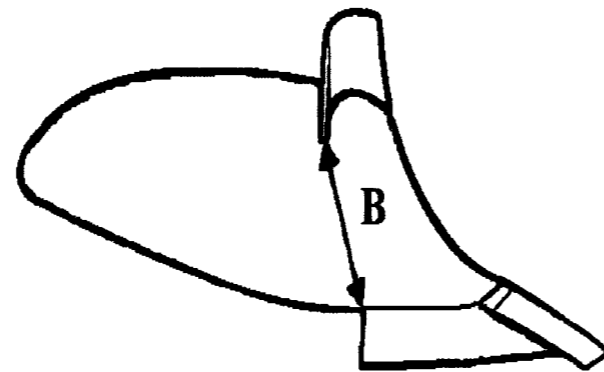

 **ÖVERUM**

Settings

Fully mounted reversible ploughs



 **ÖVERUM**

Överums Bruk AB

590 96 Överum

Sweden

Tlf. 0493-36100 • Fax. 0493-30800

sales@overums-bruk.se

www.overums-bruk.se

Subject to alternative changes reserved



Plough settings

Checking the tractor

- Tire inflation pressure
- Track width (A 3x furrow width + 10-15 cm, 0-10 cm wider in the front)
- Top link (must be easy to adjust)
- Lower link ball joints (cross-shaft parallel with the rear axle on the tractor)
- Front ballast weights

Checking the plough

- Quick couplings (correct to suit your tractor)
- Disc coulters /skimming devices
- Furrow width
- B-measurement (from instructions manual)

Mounting the plough onto the tractor

- Lower links (can they be lowered 250mm below the cross shaft?)
- Cross shaft length (L > 550mm use a long cross shaft)
- Position of the top link
- Lower links must be able to move sideways when ploughing

Cat	B	C
2	825	28
2L	965	28
3	965	36

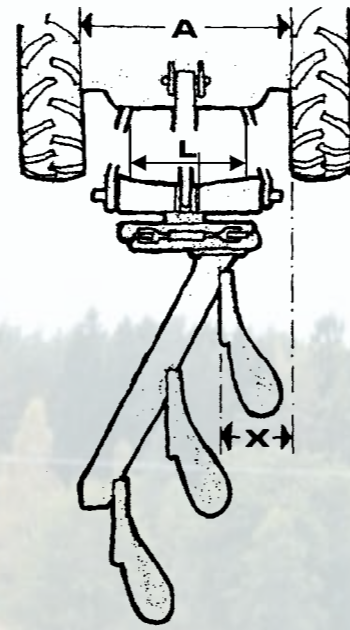
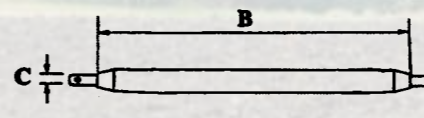

Settings

1. Vertical adjustment

- Vertical adjustment screws

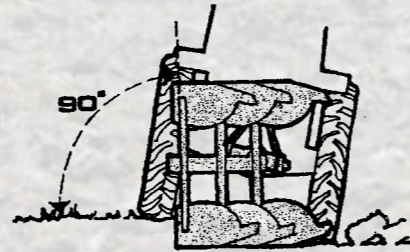

2. Horizontal adjustment

- Lower links
- Top link

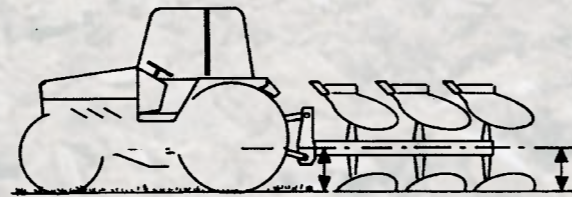

3. First furrow width

- B-measurement (turn buckle)
- A-Screw

4. Ploughing depth

- Set screws on depth wheel

5. Vertical adjustment other side

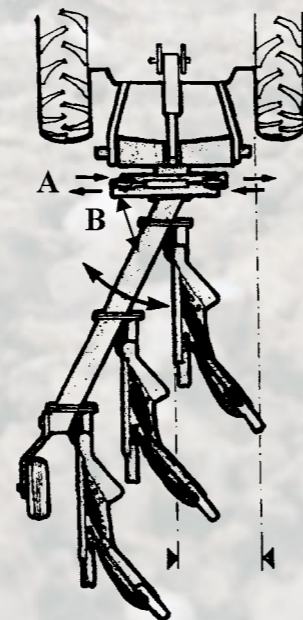

Basic settings of the front plough

1. The basic setting of the front plough can be started when the desired ploughing depth has been reached and when the tractor wheels (right or left hand pair) are running in a furrow with the same depth.

The lower links should be locked so that they not can move individually.

The top link must be mounted to the long hole on the plough headstock.

The cross shaft must always be mounted centrally in the headstock and locked with the lock collars.

Adjust basic setting of the rear furrow adjustment screw **A** and the turnbuckle **B** on the alignment cylinder (when the alignment cylinder is extended to ploughing position).

Basic setting for tractors with track width 1250mm rear and 1450mm between front wheels:

For 16"/400mm furrow width **A** = 640 mm and **B** = 700 mm

For 18"/450mm furrow width **A** = 620 mm and **B** = 715 mm

For 20"/500mm furrow width **A** = 600 mm and **B** = 730 mm

Shortening of **B**- turnbuckle = the plough moves away from the ploughed ground

Lengthening of **B**- turnbuckle = the plough moves towards the ploughed ground.

Drive forwards and check the result. If the rear furrow width do not have the same width as the other furrows, use adjustment screw **A** for adjustment.

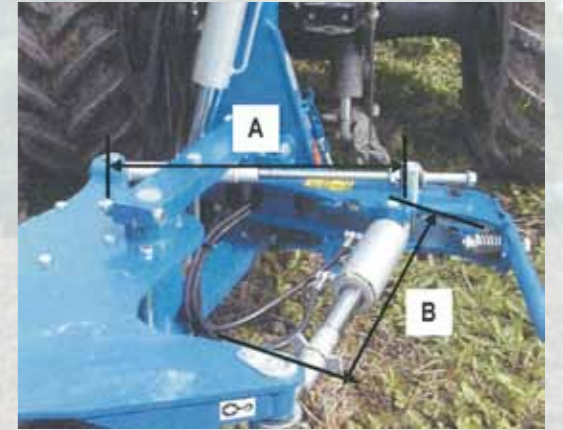

2. Vertical adjustment

The beams should be adjusted at right angles (90 °) to the ground.

The vertical adjustment of the right-hand bodies is altered with the adjustment screw on the left side of the plough, and vice-versa.



3. Horizontal adjustment

Mount the top link so that it is 5 - 10 cm lower on the tractor than on the plough when in working position. Adjust the length of the top link so that the depth of ploughing is the same for the first and last bodies (the top link pin placed in the middle of the slotted hole during ploughing). The frame will now run parallel to the ground.



4. Ploughing depth

The depth wheel runs in the previous furrow. The ploughing depth is depended on the depth of the previous furrow and the adjustment of the depth wheel. The set screws are used to set the individual depth for each side.

5. Vertical adjustment, other side

Vertical adjustment for the other side of the plough is done as per item 2

6. Checking - An easy way to control the searching adjustment is to stop during ploughing and lift the front plough. The plough shall move about 10 cm towards the unploughed ground.