

JF-STOLL

Wireless electrical operation of hydraulics

JF-Link

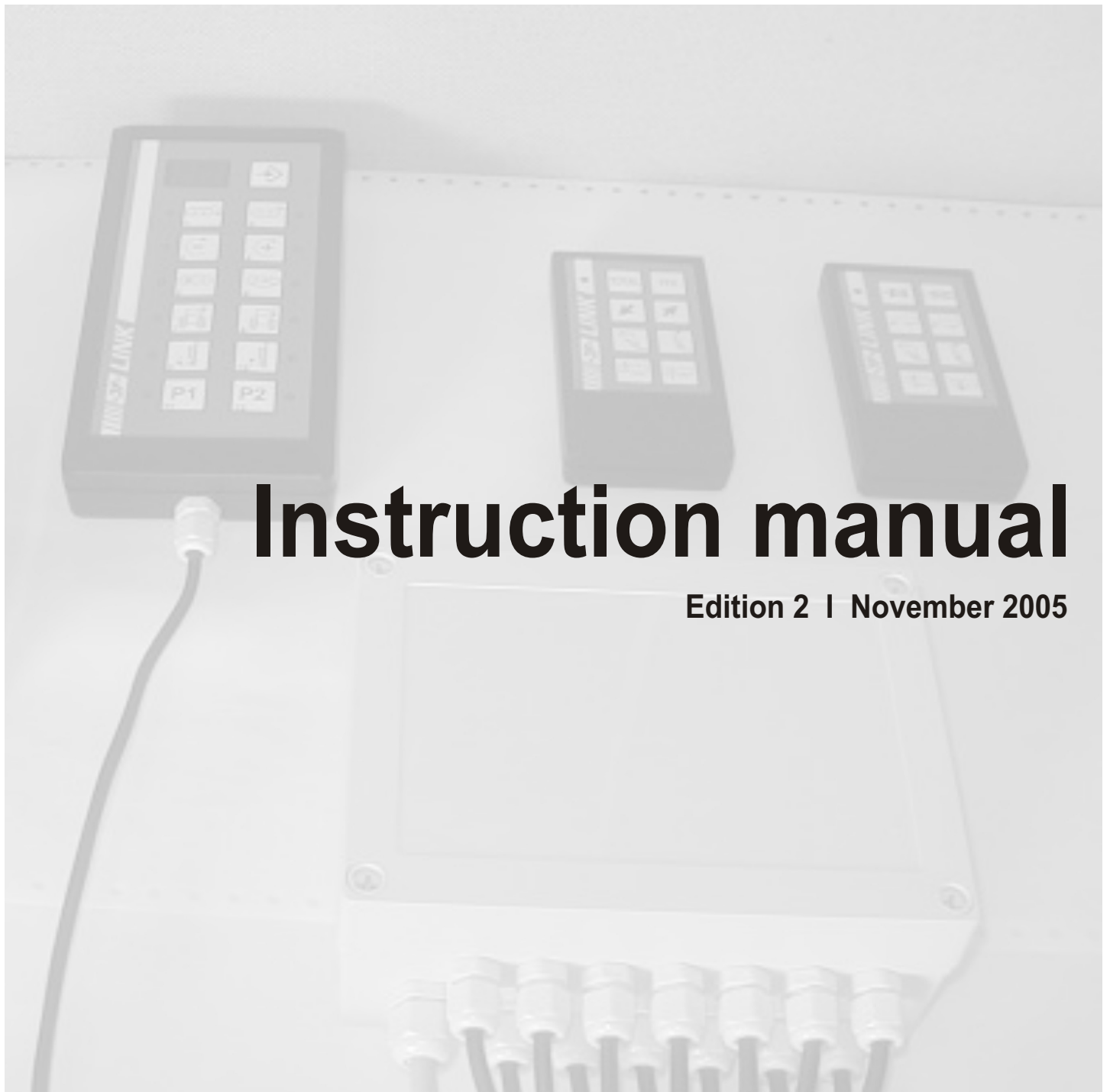

Instruction manual

Edition 2 | November 2005

CONTENTS

1. JF-LINK WIRELESS ELECTRICAL OPERATION OF HYDRAULICS	5
VALVE BOX	5
PROGRAMMING OF REMOTE CONTROL	7
REMOTE CONTROLS	9
Tractor remote control.....	9
Display.....	9
Hand remote control.....	9
FUNCTIONS.....	11
Proportional steering	11
Blocking of articulated shaft	13
Macro programs.....	13
2. MACRO SYSTEM	15
PROGRAMMING.....	15
3. OPERATION VARIANTS	17
JF FEEDER COMPLETE DIET MIXERS "VM"	17
Side doors.....	17
Hydraulic shearbars	17
Hydraulic top "Cubic+"	17
Hydraulic jack.....	17
Unloading roller.....	19
Cross conveyor	19
Elevator.....	19
Gear change	19
JF FEEDER COMPLETE DIET MIXERS "PA"	21
Side door.....	21
Hydraulic tipping of tub.....	21
Discharge with roller.....	21
Elevator.....	21
Hydraulic jack.....	21
JF MANURE SPREADER	23
Conveyor chain, speed	23
Conveyor chain, operation	23
Conveyor chain, tightening.....	23
Rear door	23
Folding up lights.....	23
4. MISCELLANEOUS	25
INTERRUPTIONS	25
HYDRAULIC DIAGRAM	25
Electric control feeder	25
Electric control manure spreader	27

1. JF-LINK WIRELESS ELECTRICAL OPERATION OF HYDRAULICS

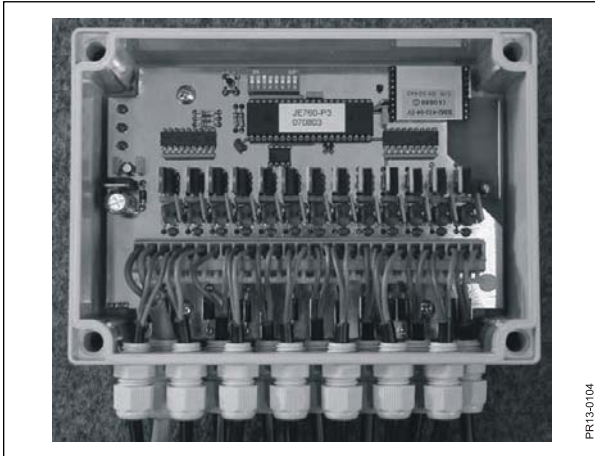

Fig. 1.1

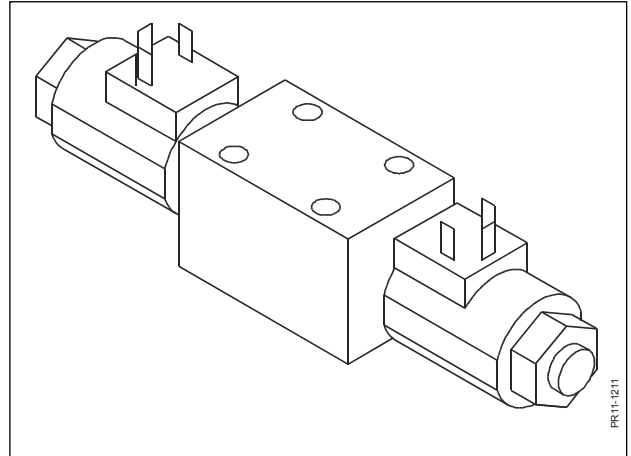

Fig. 1.2

1. JF-LINK WIRELESS ELECTRICAL OPERATION OF HYDRAULICS

JF-Link is a wireless remote control system for control of electrically operated hydraulics. The remote control operates by means of radio signals. The signals are an individual frequency unique for each single machine. Therefore, a JF-Link remote control cannot unintentionally disturb other radio based systems, even though they are within the reach of each other. In the same way, JF-Link cannot be disturbed by other radio sources. Two (or more) JF-Link systems working close together will not interrupt each other either, because sender and receiver are of a unique frequency.

A JF-Link system consists of a valve box and one or two remote controls. Either a tractor remote control *or* a hand remote control, or a tractor remote control *and* a hand remote control, or two hand remote controls. A valve box accepts only signals from one tractor remote control and one hand remote control, or two hand remote controls.

VALVE BOX

Fig. 1.1 The valve box is mounted on the machine and connected to the solenoid valves that control the hydraulic components. The valve box must be connected to 12V through a fuse of max. 10A.



To avoid flattening the battery the power supply to the machine and the remote control should be connected to the tractor, so that the supply is interrupted when the tractor ignition is turned off.

Fig. 1.2 The valve box' power consumption is maximum 50 mA; add to this up to 2.5 A for each active solenoid valve. It is therefore important to switch off the current when the tractor motor has stopped.

1. JF-LINK WIRELESS ELECTRICAL OPERATION OF HYDRAULICS

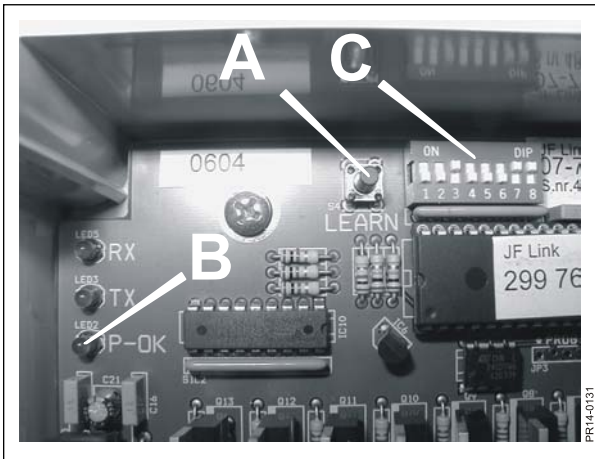

Fig. 1.3

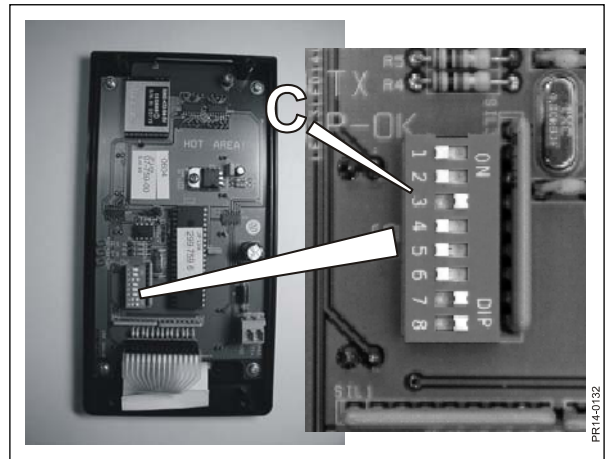

Fig. 1.4

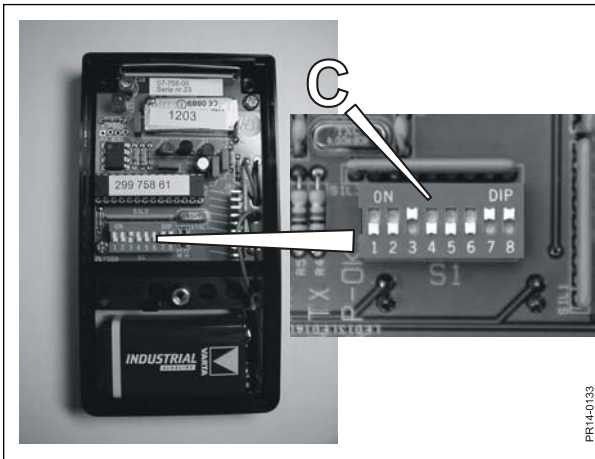

Fig. 1.5

PROGRAMMING OF REMOTE CONTROL

The safety in the system is based on the fact that maximum 2 remote controls, are identified by the valve box, are allowed to operate the hydraulic outlets. All remote controls during production are equipped with a unique (electronic) serial number used for identification.

Fig. 1.3 Programming of the remote control implies that all units in the system are set up to the

Fig. 1.4 same function variant on DIP1 – DIP4 (**C**). That is to say DIP1 – DIP4 must be set identically in the valve

Fig. 1.5 box and remote control(s) in order to communicate with each other.

Fig. 1.3 In order to program a new remote control the procedure below must be followed:

- 1) Check that the dips (**C**) are set identically.
- 2) Connect battery / power supply to the valve box and remote control(s).
- 3) Press the "LEARN"-button (**A**) in the valve box. LED "OK" (**B**) lights up constantly after approx. 3 seconds. Stop pressing the button.
- 4) Activate an arbitrary button on the remote control that is to be programmed / reported.
- 5) The constant light in LED "OK" goes out and a flash appears in all LEDs as during normal operation. The remote control is now programmed.

In case you want to delete programmed remote controls, push the "LEARN"-button for approx. 9 seconds. When the LED "OK" flashes, the 9 seconds are up and no remote controls can communicate with the valve box.

1. JF-LINK WIRELESS ELECTRICAL OPERATION OF HYDRAULICS



Fig. 1.6

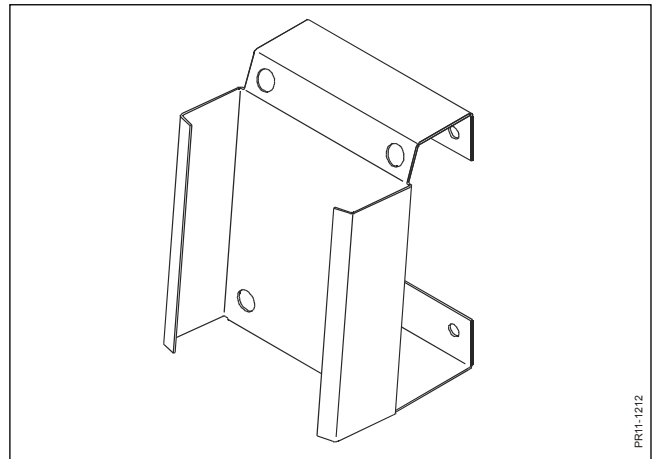

Fig. 1.7

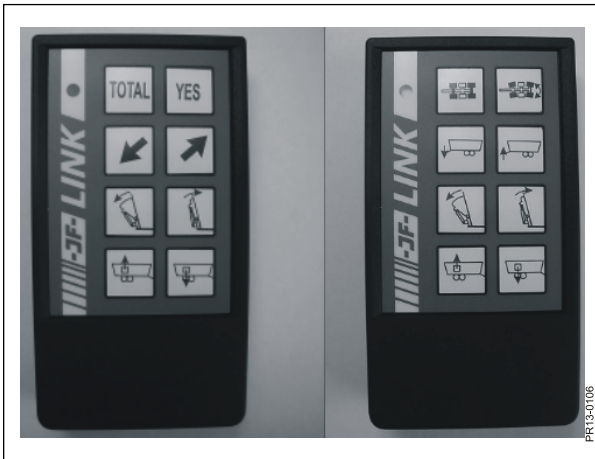

Fig. 1.8



Fig. 1.9

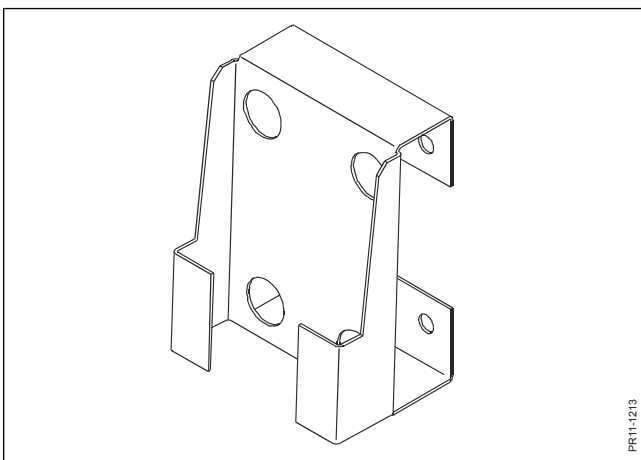

Fig. 1.10

REMOTE CONTROLS



TRACTOR REMOTE CONTROL

- Fig. 1.6** The tractor remote control is intended for mounting in the tractor cabin.
- Fig. 1.7** The included holder may be used for this purpose. The holder may carefully be adjusted to fit perfectly. The remote control must be connected to 12V (8-24V) through a fuse of max. 5A. Power consumption is up to 100 mA.

The remote control is supplied with a feedback function. The feedback function shows whether the communication between remote control and valve box works the way it should. When a button on the remote control is activated, a signal is sent to the valve box receiver. The receiver subsequently sends a signal back to the remote control and the light-emitting diode next to the button in question switches on to indicate that the communication succeeded.

- Fig. 1.8** If a hand remote control is also used (see below) the valve box' feedback signals from the hand remote control will also be registered on the tractor remote control. You can thus see on the tractor remote control when the hand remote control is being used.

DISPLAY

- Fig. 1.9** When starting up the display in the top left corner of JF-LINK shows:  When the first contact to the machine is established the display changes to showing proportional step e.g.: , however, only if proportional valve has been used on the machine.

The dot in the lower right corner on the display  is the "Power" indicator, which indicates that the remote is switched on.

The dot in the middle below:  follows the sending of data. Thus, here can be seen whether data is being sent.

HAND REMOTE CONTROL

- Fig. 1.8** The hand remote control is supplied by 1 9V battery. The remote control can be used when loading or mixing, from where a potential hydraulic top or hydraulic shearbars can be operated. The remote control is produced in two versions. One version for 4 hydraulic functions (right) as well as a version for remote control of the weighing system for complete diet mixers and 2 hydraulic functions (left).
- Fig. 1.10** The remote control is delivered with a holder that can be mounted in the tractor cabin.

1. JF-LINK WIRELESS ELECTRICAL OPERATION OF HYDRAULICS



Fig. 1.11

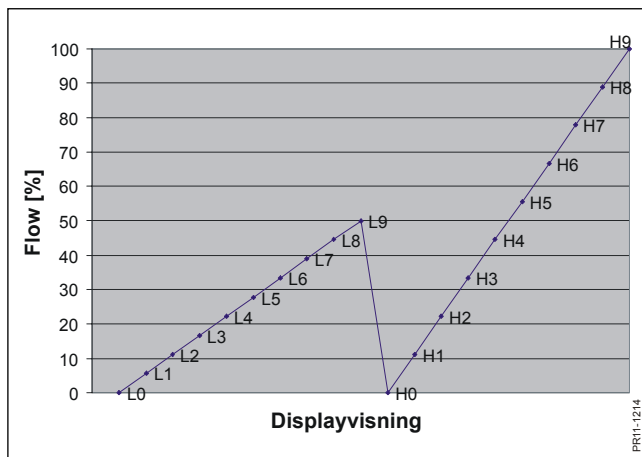

Fig. 1.12

FUNCTIONS

Below is a list of the functions that JF-Link can contain. What functions are on a given remote control depend on what machine it has been delivered for and the additional equipment that has been delivered with the machine.

The functions can control 4 different hydraulic components.

1. Single acting cylinders.
2. Double acting cylinders
3. Motors.
4. Proportional valves.

The operation is different according to what component is controlled and what machine part is activated.

PROPORTIONAL STEERING

Fig. 1.11 This function only exists on the tractor remote control. The function is used for adjustment of a motor's rpm. The adjustment takes place in a low and a high area each with 10 steps.

In the remote control display an **L** or an **H** is shown depending on what area is active.





The actual step is shown with a number: **0 – 9**. When pressing  the speed is increased one step, and when pressing  the speed is decreased one step. If a button is held down the steps shift continuously until the button is released.

Fig. 1.12 Speed area **L** goes from **L0** to **L9**. This area is intended for adjustment of slow motors i. e. for driving a conveyor chain. The amount of oil can be adjusted from 0 to approx. 50% of maximum oil amount. Area **H** goes from **H0** to **H9**. This area is used for high-speed motors i. e. for an unloading belt.

The speed areas **L** and **H** are in continuation of each other.

When pressing  and  at the same time, speed is increased to **H9** (maximum speed) until the buttons are released again. When the buttons are released the system returns to the step that was last active for 10 or more seconds.

1. JF-LINK WIRELESS ELECTRICAL OPERATION OF HYDRAULICS



Fig. 1.13

BLOCKING OF ARTICULATED SHAFT

Fig. 1.13 This function is used for blocking and opening of articulated shafts. Remember always to block the articulation before reversing the machine!

When pressing quickly (approx. 1 second) on  oil is sent to the articulation cylinder for approx. 10 seconds placing all tyres in parallel position.

It is therefore not necessary to press the button for a long time in order to make sure that the cylinders have reached the locking position.

Due to wear on tyres you should only reverse straight backwards, avoid as far as possible to turn and reverse at the same time.

Open the articulation by pressing  when driving forward again.



When speed exceeds 20 km/h we recommend blocking of the articulation shaft!

Note, when the articulation is opened the output uses approx. 2.5A until the articulation is blocked again or the power supply is cut off. It is therefore important that the power supply to JF-Link is cut off when the machine is not in use, because otherwise the tractor battery will be flat after short time (maximum 24 hours).

MACRO PROGRAMS

These buttons can be programmed to carry out optional operation sequences. See more information about this in the section JF-Link Macro system.

2. MACRO SYSTEM

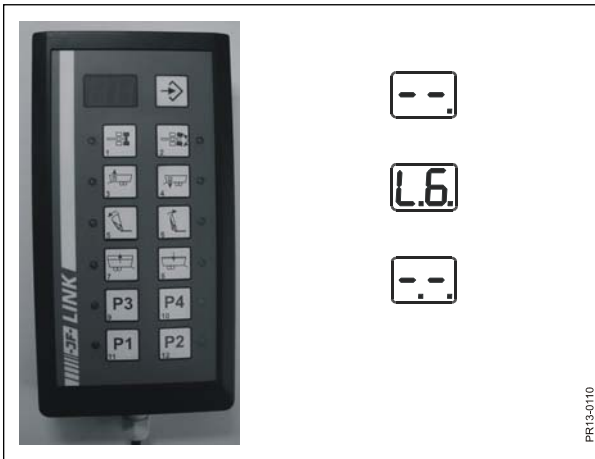

Fig. 2.1

2. MACRO SYSTEM

Fig. 2.1 The macro system allows programming of up to 4 operation sequences or programs consisting of up to 15 steps. The buttons that can be programmed are marked with **P**. (P1, P2 ...).

Programs are stored as "pressure" commands i.e. no regard is paid to the result of the action, just that it is carried out in the same period of time and in the same interval as it was programmed. In order for the programs to function correctly all cylinders must be in the same position when the program is executed as they were when it was programmed.

The only exception is a proportional valve. Here the program remembers what level it was set for, and not how many buttons that were pressed.

PROGRAMMING

Fig. 2.1 Press the programming button:  until the "P"-buttons start to flash. Press the "P"-button on which you would like to program to be stored. (Here after only this button will flash).

Carry out the desired sequence: Activate cylinders, start/stop motors etc.

When the desired sequence is carried out press the programming button:  and the program is saved and ready for use.

The program is now carried out every time the "P"-button in question is pressed. A program can be interrupted by pressing a *non* "P"-button.



REMEMBER: In order for the programs to work as intended, the cylinders that are operated by the program **must** be in the same position as immediately before the program was programmed.

If you would like the program to be changed, simply carry out a new programming as described above and the old program is deleted.

Programs are stored locally in the JF-Link remote control, and do not pay regard to the fact that settings are changed. If the machine is changed with one or more hydraulic functions, the programs must be re-programmed in order to work correctly. On the other hand, the programs can be used together with another machine with the same settings.

If the power is cut off during programming, the information will not be stored. Normally, the last programmed sequence is always remembered, no matter whether the power is on or not.

3. OPERATION VARIANTS

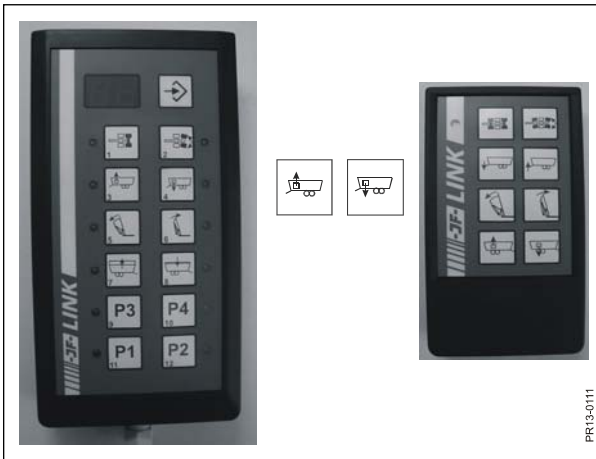

Fig. 3.1



Fig. 3.2

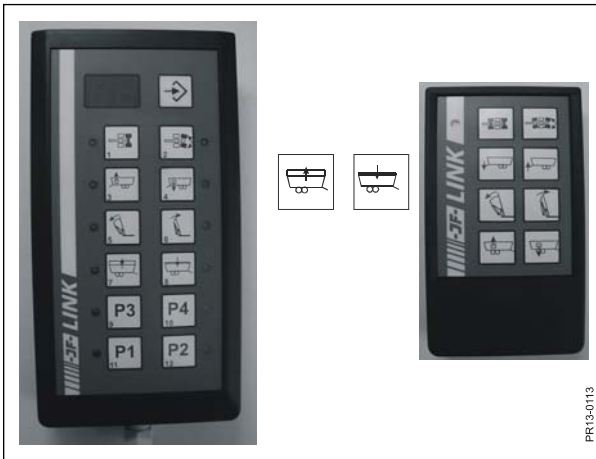

Fig. 3.3

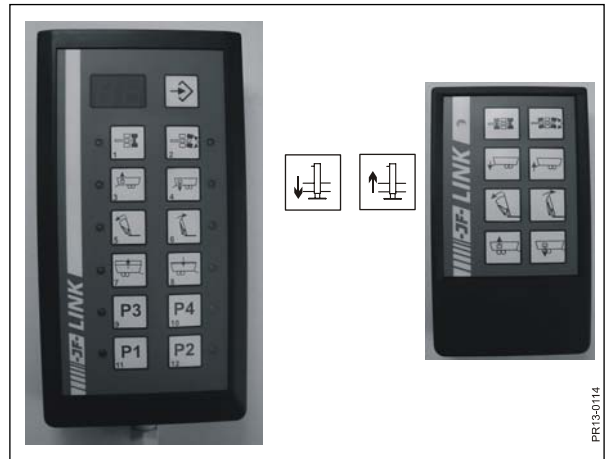



Fig. 3.4

3. OPERATION VARIANTS

JF FEEDER COMPLETE DIET MIXERS "VM"

SIDE DOORS

Fig. 3.1 Is used to open and shut side doors. The drawing on the button indicates which side door on the machine this button controls.

Press  and the side door will open.

Press  and the side door will close.

The movement of the side doors will stop when the buttons are released.

HYDRAULIC SHEARBARS

Fig. 3.2 Control the shearbars in order to optimise the chopping degree. The shearbars will move as long as the buttons are pressed.

Press  and the shearbars will be pulled out.

Press  and the shearbars will be pushed in and make the chopping more aggressive.

HYDRAULIC TOP "CUBIC+"

Fig. 3.3 Raises and lowers the Cubic+ top.

Press  and Cubic+ will be raised.

Press  and Cubic+ will be lowered.

The movements will stop when the buttons are released.

HYDRAULIC JACK

Fig. 3.4 Is used to raise and lower the drawing eye by means of the hydraulic jack.

Press  and the drawing eye will be lowered.

Press  and the drawing eye will be raised.

The movements will stop when the buttons are released.

3. OPERATION VARIANTS



Fig. 3.5



Fig. 3.6

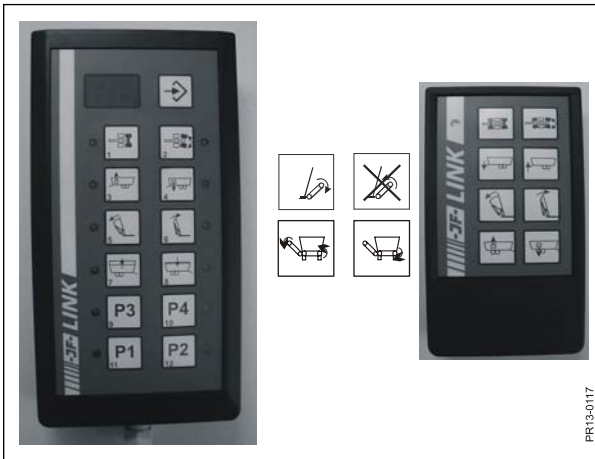

Fig. 3.7



Fig. 3.8

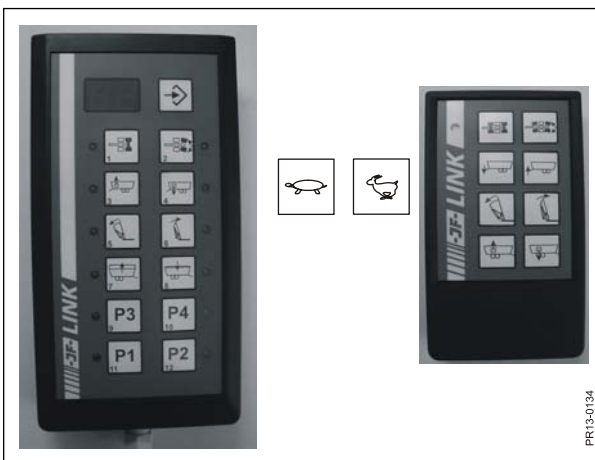



Fig. 3.9

UNLOADING ROLLER

Fig. 3.5 Controls the rotation of the unloading roller.

Press  and the roller will start unloading. The roller will stop unloading if one of the two buttons is pressed.

Press  and the roller will reverse until the button is released. The cross means that the button should not be used. It is solely intended for situations where the roller needs to be reversed in case of a blockage.

CROSS CONVEYOR

Fig. 3.6 Starts and stops the cross conveyor.

Press  to start the cross conveyor unloading to the right.

Press  to start the cross conveyor unloading to the left.

The cross conveyor will stop when one of the two buttons is pressed.

ELEVATOR

Fig. 3.7 Starts and stops the unloading belt of the elevator.

Press  and the unloading belt will start.



The cross  means that the button should solely be used to repair a potential blockage. However, the unloading belt will stop if this button is pressed.

Fig. 3.8 Raises and lowers the elevator between unloading position and transport position.

Press  in order to lower the elevator into unloading position.

Press  in order to raise the elevator into transport position.

The movements will stop when the buttons are released.

GEAR CHANGE

Fig. 3.9 Changes gear on the reduction gear.

Press  in order to change down. Oil pressure is on for 20 seconds. Therefore, the PTO shaft should be activated within these 20 seconds, in order for the gear to fall into place, if this has not already happened.

Press  in order to change up. Oil pressure is on for 20 seconds. Therefore, the PTO shaft should be activated within these 20 seconds, in order for the gear to fall into place, if this has not already happened.

3. OPERATION VARIANTS



Fig. 3.10

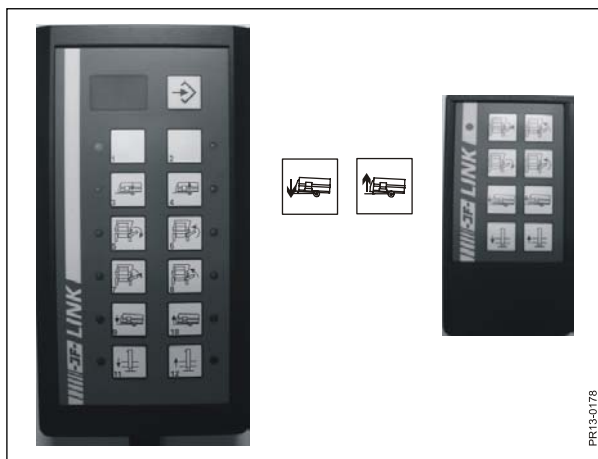

Fig. 3.11

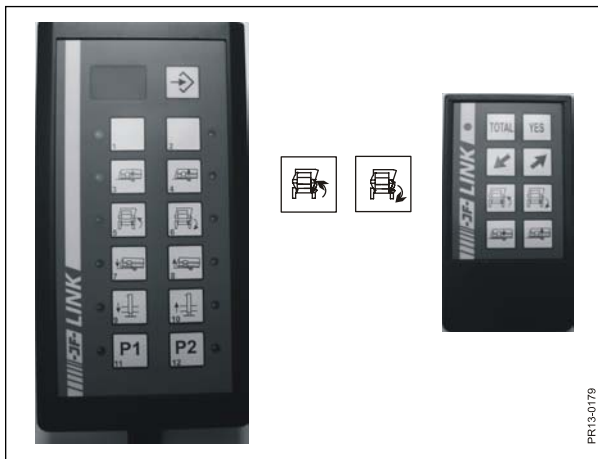

Fig. 3.12

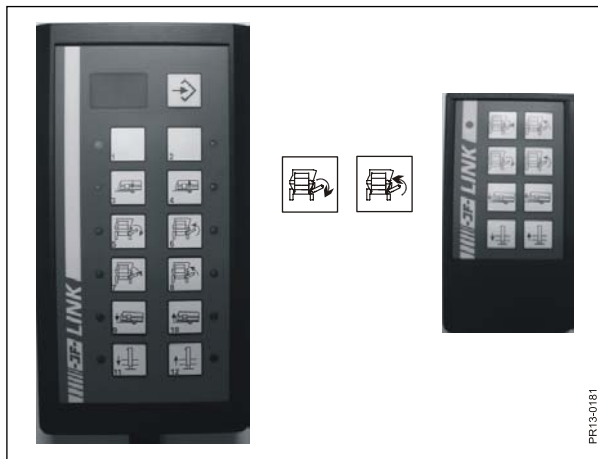

Fig. 3.13

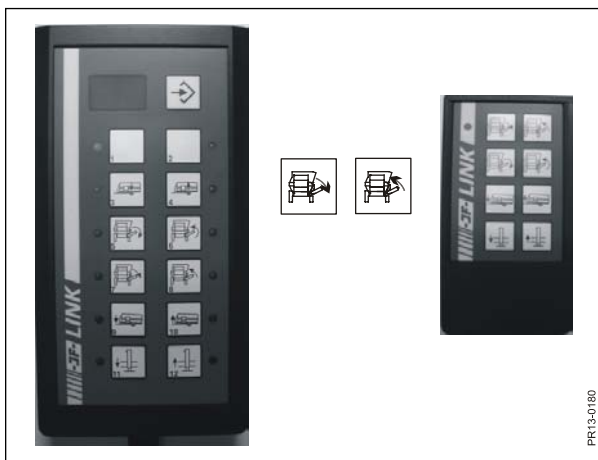

Fig. 3.14

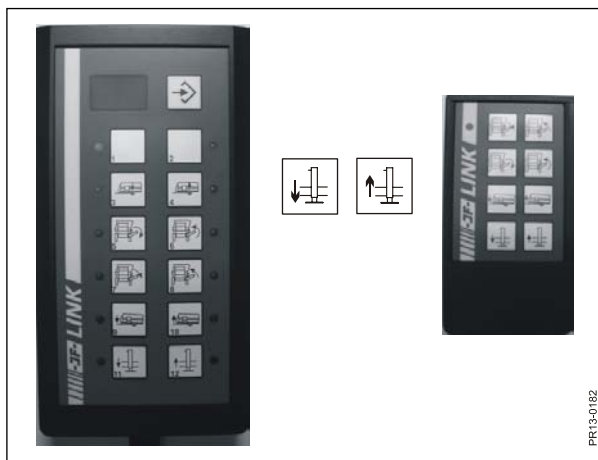



Fig. 3.15

JF FEEDER COMPLETE DIET MIXERS "PA"

SIDE DOOR

Fig. 3.10 Is used to open and shut the side door.

Press  and the side door will open.

Press  and the side door will close.

The movement of the side door will stop when the button is released.

HYDRAULIC TIPPING OF TUB

Fig. 3.11 This function is used to adjust the tub to horizontal position, or to lower the tub a little, when it is almost empty in connection with discharge.

Press  and the front end of the tub is tipped downwards.

Press  and the front end of the tub is tipped upwards.

DISCHARGE WITH ROLLER

Fig. 3.12 Starts and stops the roller under the side door.

Press  and the roller will start.

Press  and the roller will stop. The roller should only turn backwards for a short period, to avoid risk of blockage.

ELEVATOR

Fig. 3.13 Starts and stops the unloading belt of the elevator.

Press  and the unloading belt will start.



The cross  means that the button should solely be used to repair a potential blockage. However, the unloading belt will stop if this button is pressed.

Fig. 3.14 Raises and lowers the elevator between unloading position and transport position.

Press  in order to lower the elevator into unloading position.

Press  in order to raise the elevator into transport position.

The movements will stop when the buttons are released.

HYDRAULIC JACK

Fig. 3.15 Is used to raise and lower the drawing eye by means of the hydraulic jack.

Press  and the drawing eye will be lowered.

Press  and the drawing eye will be raised.

The movements will stop when the buttons are released.

3. OPERATION VARIANTS



Fig. 3.16



Fig. 3.17



Fig. 3.18

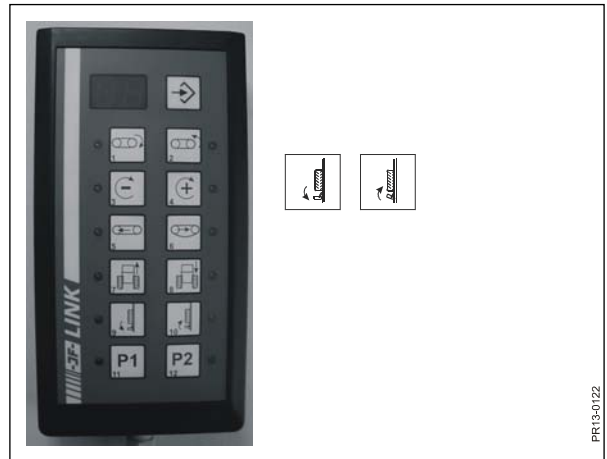

Fig. 3.19

JF MANURE SPREADER

CONVEYOR CHAIN, SPEED

See page 11 “proportional steering”.

CONVEYOR CHAIN, OPERATION

Fig. 3.16 Starts, stops and reverses the conveyor chain.

Press  and the conveyor chain will start. The conveyor chain will stop when one of the two buttons is pressed.

Press  and the conveyor chain will reverse. Note: The conveyor chain is tightened before the reversing starts. Therefore, the conveyor chain will not start until the chain is tight – which takes approx. 2 seconds. The tightening of the conveyor chain will continue during the reversing. The reversing will stop when the button is released.

CONVEYOR CHAIN, TIGHTENING

Fig. 3.17 Tightens and slackens the conveyor chain.

Press  and the roller will tighten until the button is released.

Press  and the conveyor chain will slacken. The chain will slacken almost momentary as the return device is opened and oil runs back to tank. Both functions stop when the buttons are released.

REAR DOOR

Fig. 3.18 Opens and closes the rear door.

Press  and the rear door will open.

Press  and the rear door will close.
The movements will stop when the buttons are released.

FOLDING UP LIGHTS

Fig. 3.19 Folds rear lights in and out in working position and transport position.

Press  and the rear lights are folded out in transport position.

Press  and the rear lights are folded in in working position.
The movements will stop when the buttons are released.

4. MISCELLANEOUS

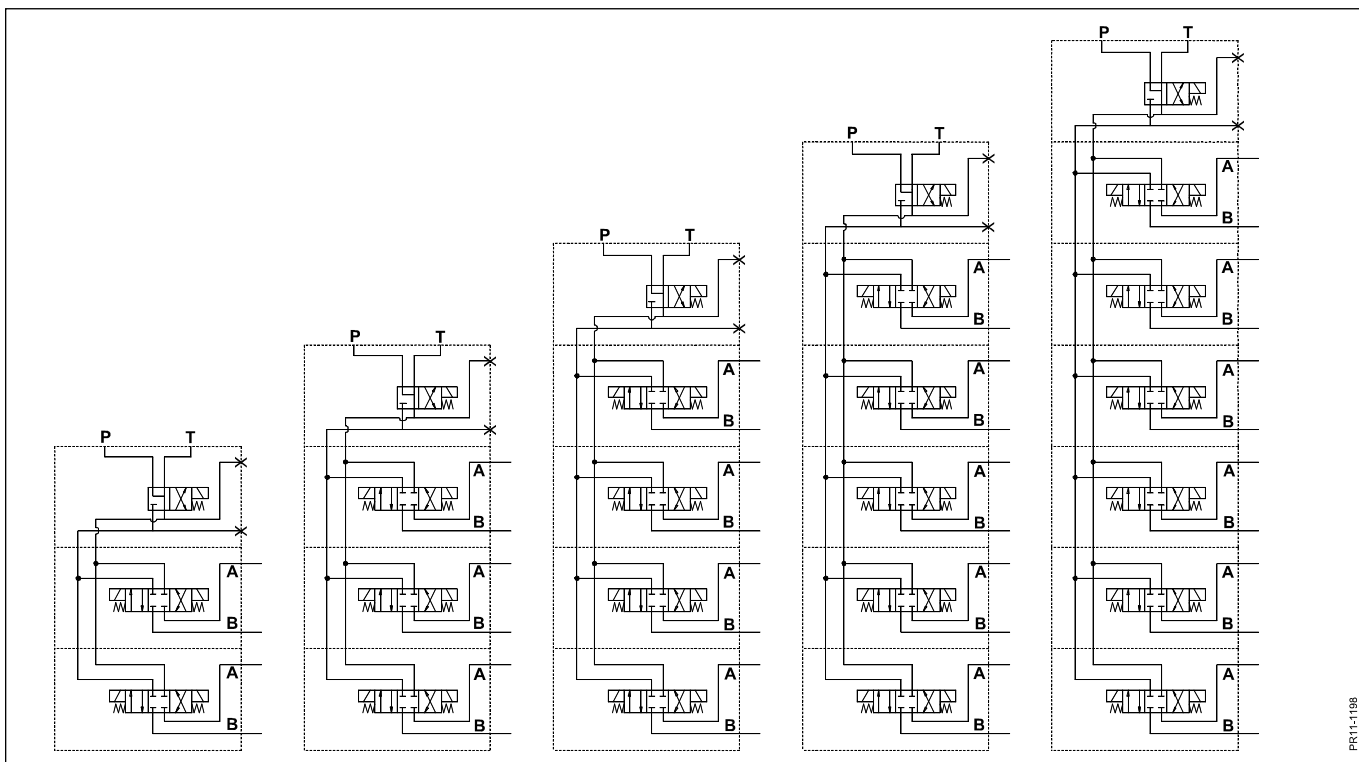

Fig. 4.1

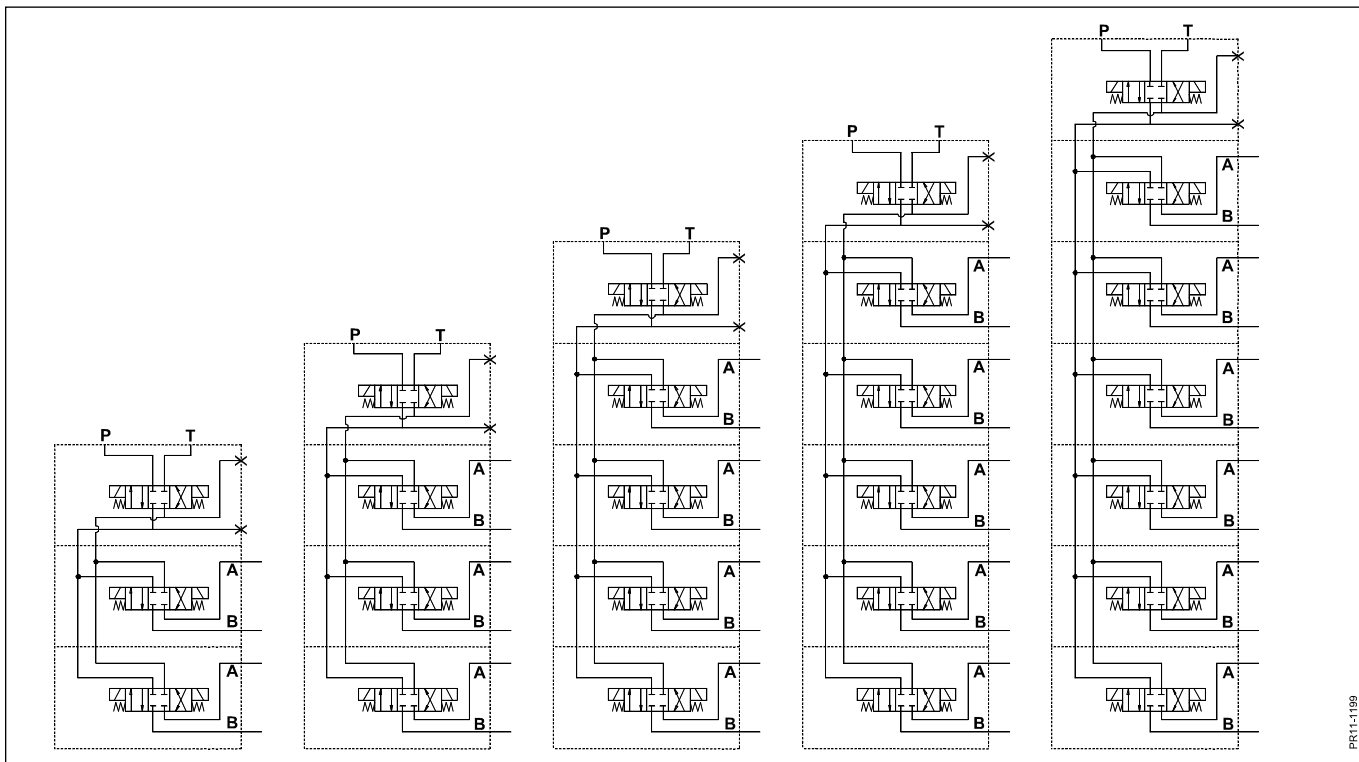

Fig. 4.2

4. MISCELLANEOUS

INTERRUPTIONS

PROBLEM	POSSIBLE CAUSE	REMEDY
No light in the remote control	The battery is flat.	Change the battery.
No reaction when buttons are pressed.	Poor signal communication.	Radio noise source close by must be turned off.
The battery is being flattened.	There is power on the valve box. The function "articulation unlocked" and the proportional valve (except from the positions L0 and H0) are permanent current-consumers.	Cut off the power to the valve box when the tractor is not running.
When the button on the remote control is released the function continues for a little while.	Due to the safe wireless communication there is a delay of approx. 0.3 seconds.	Nozzles/throttle pieces can be used in order to make the function move slower. There are 2 versions: 2010-394x (ø 1.5) and 2307-111x (ø 0.8)

HYDRAULIC DIAGRAM

ELECTRIC CONTROL FEEDER

Fig. 4.1 Valve block for electronic operation of 2-6 hydraulic functions.

P = Pressure hose (red cap)

T = Return hose (blue cap)

A and **B** are the connections to and from the various hydraulic functions on the machine.

Fig. 4.2 Valve block for electronic operation of 2-6 hydraulic functions on a tractor equipped with a pressure compensated pump system (e.g. John Deere hydraulics).

P = Pressure hose (red cap)

T = Return hose (blue cap)

A and **B** are the connections to and from the various hydraulic functions on the machine.

4. MISCELLANEOUS

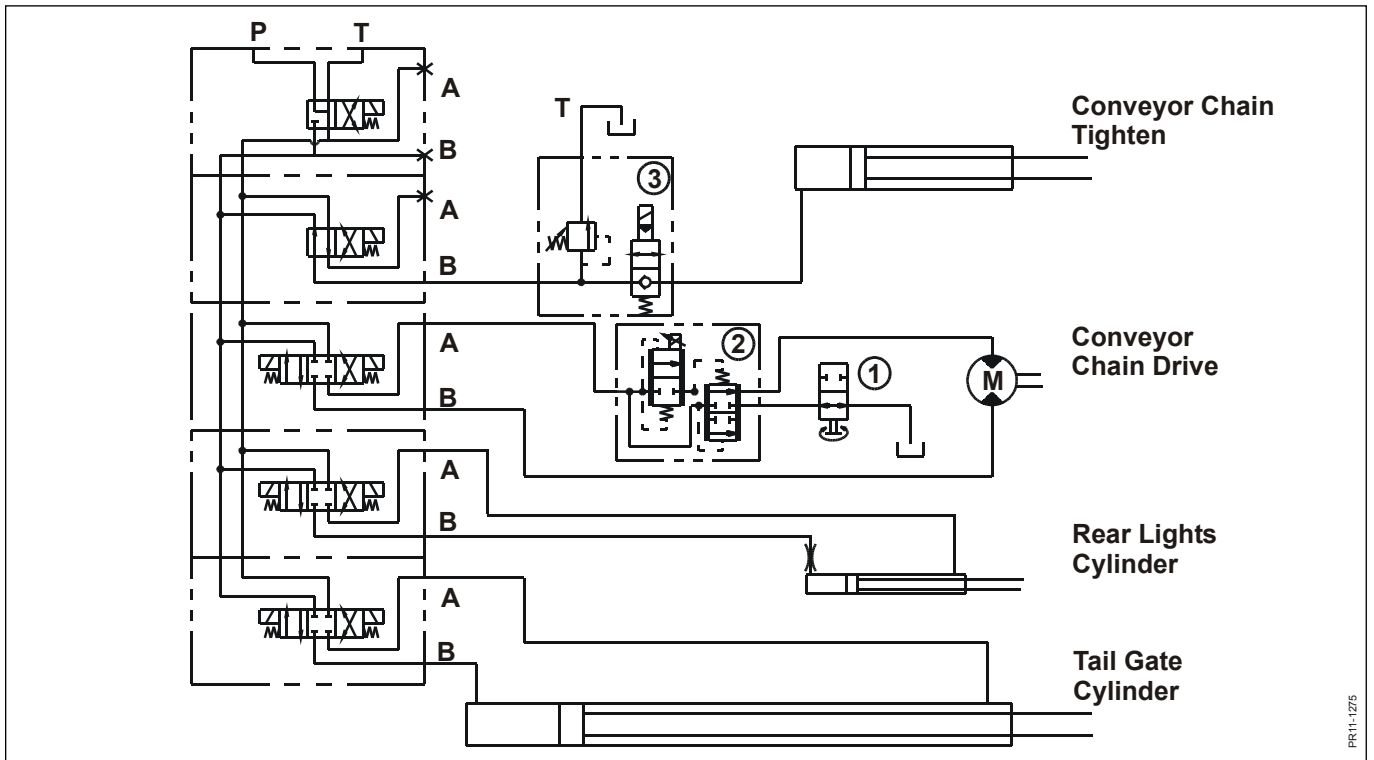

Fig. 4.3

ELECTRIC CONTROL MANURE SPREADER

Fig. 4.3 Hydraulic diagram

- 1) Manually operated ball valve
- 2) Flow regulating valve
- 3) Overflow valve (40 bar)

FOR OWN NOTES



Specialist in grass technique

When it comes to green feed techniques, JF-Stoll has gained a reputation as one of the world's leading suppliers and specialists. As a specialist manufacturer for over 50 years, we have gained a vast amount of experience from right around the world and, more importantly, unique regional requirements.

We also receive important inspiration in our development work through a close and continuous dialogue with customers, dealers and agricultural researchers. No matter what type of JF-machine you chose you are sure to obtain the best result regarding high yield and operational reliability, minimal maintenance, flexible working possibilities and optimal business economics.



Dealer

JF-STOLL

JF-Fabriken · J. Freudendahl A/S
Linde Allé 7 · Postbox 180
DK-6400 Sønderborg · Denmark
Phone. +45 74 12 51 51 · Fax +45 74 42 52 51
www.jf-stoll.com